

# SUMAS<sup>TM</sup> Media

## SM-3805



## USER OPERATION MANUAL

# TABLE OF CONTENTS

Safety Information.....	1
Park wire/ Brake wire.....	1
Installation/Removal .....	2
Playable Disc, DVD Care, MP3 .....	3
Maintenance.....	3
Replacing Remote Control Battery.....	3
Remote Control .....	4
Remote Control Functions .....	5
Front Panel .....	6
Front Panel Functions .....	7
Basic Setup.....	8-9
Radio Mode .....	10
Music/MP3 Mode .....	10
DVD Mode .....	10
USB Mode .....	11
Auxiliary Mode .....	11
Rear Camera.....	11
Trouble Shooting .....	12
Specification .....	13
Accessories .....	14

## Safety Information

Please read this manual thoroughly and keep in your vehicle for easy future reference. We highly recommend that you find a licensed professional installer for the installation of this product, it is illegal to watch DVD player while driving.

**CAUTION:** This unit is a class 1 Laser Product. To prevent direct exposure to Laser system, DO NOT OPENS the unit. The Laser Beam may hurt or damage your eyes. If the unit requires adjustments, please contact an authorized service center.

### USE THIS PRODUCT SAFELY

Make sure you fully understand the following safety information:

#### When Driving

Keep the unit at an appropriate sound level. Driving with the sound at a level that prevents you from hearing the sounds outside and around the car may cause an accident.

#### When cleaning your interior

Do not expose the product to water or excessive moisture. This could cause short circuit, fire or other severe damage to the unit or you vehicle.

#### When Parked

Parking in direct sunlight especially in the summer time can produce very high temperature inside you vehicle. This may cause the unit to not work properly. Let the interior of your car to cool down before turning on the unit.

**Note:** Do not use and store player in dusty, high temperature or high humidity Environments.

#### Park wire/Brake wire

Park wire is to connect to your parking brake (Hand brake) or your unit will not function, also for your safety; when car is operate will restrict you to play/watch DVD while driving, display shows: safety off, do not play DVD,

But some make or model of automobile if you have problem to connect to your brake, you can also ground this wire to your car's chassis, unit will play; but restriction will be disabled, so please do not watch your unit when driving!

#### Replacing the Fuse

When replacing the fuse, be sure to use one matching the amperage rating stated on the original fuse.



### **WARNING!**

**NEVER** replace any Fuse with higher amperage than the original. This may cause damage to your unit and/or your vehicle's electrical wiring.

## INSTALLATION

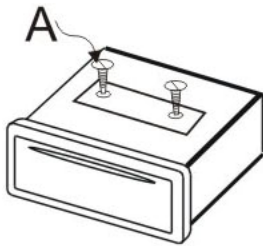

Note: Remove the shipping protection two screws (A)  
Before installing and operating the unit.

**Please find the front panel inside carry caddy. Reinstall panel by placing as flipped down position, gently insert panel left side into front adaptor first, then gently click right side into place. When completed correctly panel should be flipping up in place.  
To remove the panel, gently pull out the right side first after flipped down.**

- This unit is designed for 12V DC; (connecting to other than 12V will cost unit damage), negative ground operation system only.
- When replacing a fuse, be sure to use one matching the amperage rating stated on the original fuse. Using a fuse with the wrong Rating may cause your unit not function correctly or even cause electrical shortage
- The negative battery terminal must be disconnected before making connections, which can reduce damaging the unit due to short circuit.
- Be sure to connect the color coded leads correctly according to the wiring diagram. Incorrect connections may cause damage or malfunction and may damage the vehicle's electrical system.
- Be sure to connect the speaker (-) leads to the speaker (-) terminal, and the speaker (+) leads to the speaker (+) speaker terminal and so on. Never connect the left and right channel speaker cables to each other or to the vehicle body.
- Do not block the vents or radiator panels. Blocking them will cause heat to build up inside and may damage your unit.
- After the completion of the installation. Plug in negative cable of vehicle to the (-) battery terminal. Then press the RESET button the front panel with a pointed object (such as ball-point pen) to set the unit to initial status. Please refer to page 6.

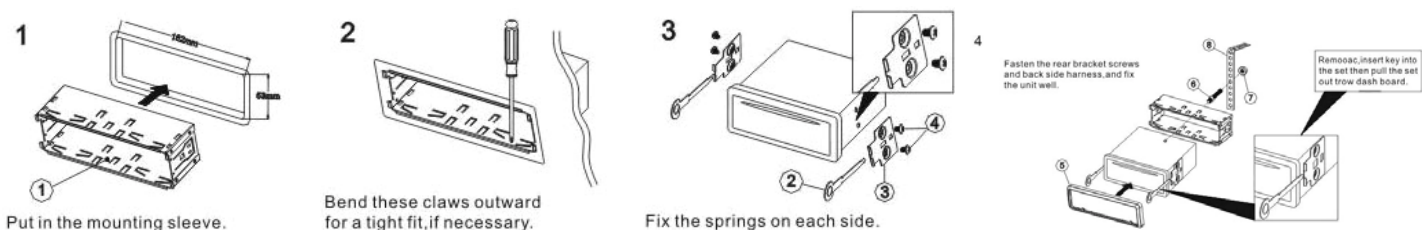

### Unit Installation & Removal

## Playable discs

DVD, Video CD and CD discs that display the logos shown below can be played back on this unit.



DVD video disc region numbers:

(This unit is for region one only)

**If you encounter region problems, please call toll free service number on back page, we will help you resolve it.**

## DVD Care

If you use an irregular disc it may jam the DVD player or not play, for this reason only use round discs

Be sure to check all discs for cracks and scratches before playing, discs in those conditions will not play properly.

Also, be sure to avoid the recorded (plain) side of the disk

Store CDs in case when not in use to avoid scratching the disc.

Keep discs out of direct sunlight (it will cause them to warp and crack)

to clean the CDs wipe with a soft cloth from the inside of the disc outward

## MP3

MP3 files on CD-ROM, CD-R and CD-RW are compatible with this unit.

Discs compatible with ISO9660 level one and two or with ROMEO and JULIET, recorded discs with the multi sections can also be played.

MP3 files are incompatible with the transportation of read-in files.

The max character width of the folder name is 32. If the file is recorded through ROMEO and JULIET system, only the former 32 characters are displayed. While playing discs with MP3 and CD-DA, such as CD EXTRA and MIXED MODE CD the system can only switch between MP3/4 and CD-DA. The selected folder sequence of playing and other operations will be the sequence to write in the software. So the anticipated sequence of playing should not conflict with the actual playing sequence. However, there is, indeed some software that play sequence is allowed to be set. The file is compatible with Id3 label version 1.0 and 1.1, so as to display the music titles and authors. The enhancing function is valid only when playing MP3/4 in 32, 44.1 and 48 KHz sample frequencies 16,22,05,24, 32, 44.1 KHz can be played.

The tone of MP3s file can usually be bettered when the bit rate is increased. This machine can play recordings between 8KBPS and 320 KBPS. However, in order to enjoy a good tone, we recommend discs over 128KBPS.

The tone of MP3s file can usually be bettered when the bit rate is increased. This machine can play recordings between 8KBPS and 320 KBPS. However, in order to enjoy a good tone, we recommend discs over 128KBPS.

The tone of MP3s file can usually be bettered when the bit rate is increased. This machine can play recordings between 8KBPS and 320 KBPS. However, in order to enjoy a good tone, we recommend discs over 128KBPS.

The tone of MP3s file can usually be bettered when the bit rate is increased. This machine can play recordings between 8KBPS and 320 KBPS. However, in order to enjoy a good tone, we recommend discs over 128KBPS.

The tone of MP3s file can usually be bettered when the bit rate is increased. This machine can play recordings between 8KBPS and 320 KBPS. However, in order to enjoy a good tone, we recommend discs over 128KBPS.

The tone of MP3s file can usually be bettered when the bit rate is increased. This machine can play recordings between 8KBPS and 320 KBPS. However, in order to enjoy a good tone, we recommend discs over 128KBPS.

The tone of MP3s file can usually be bettered when the bit rate is increased. This machine can play recordings between 8KBPS and 320 KBPS. However, in order to enjoy a good tone, we recommend discs over 128KBPS.

The tone of MP3s file can usually be bettered when the bit rate is increased. This machine can play recordings between 8KBPS and 320 KBPS. However, in order to enjoy a good tone, we recommend discs over 128KBPS.

The tone of MP3s file can usually be bettered when the bit rate is increased. This machine can play recordings between 8KBPS and 320 KBPS. However, in order to enjoy a good tone, we recommend discs over 128KBPS.

The tone of MP3s file can usually be bettered when the bit rate is increased. This machine can play recordings between 8KBPS and 320 KBPS. However, in order to enjoy a good tone, we recommend discs over 128KBPS.

The tone of MP3s file can usually be bettered when the bit rate is increased. This machine can play recordings between 8KBPS and 320 KBPS. However, in order to enjoy a good tone, we recommend discs over 128KBPS.

The tone of MP3s file can usually be bettered when the bit rate is increased. This machine can play recordings between 8KBPS and 320 KBPS. However, in order to enjoy a good tone, we recommend discs over 128KBPS.

The tone of MP3s file can usually be bettered when the bit rate is increased. This machine can play recordings between 8KBPS and 320 KBPS. However, in order to enjoy a good tone, we recommend discs over 128KBPS.

The tone of MP3s file can usually be bettered when the bit rate is increased. This machine can play recordings between 8KBPS and 320 KBPS. However, in order to enjoy a good tone, we recommend discs over 128KBPS.

The tone of MP3s file can usually be bettered when the bit rate is increased. This machine can play recordings between 8KBPS and 320 KBPS. However, in order to enjoy a good tone, we recommend discs over 128KBPS.

The tone of MP3s file can usually be bettered when the bit rate is increased. This machine can play recordings between 8KBPS and 320 KBPS. However, in order to enjoy a good tone, we recommend discs over 128KBPS.

The tone of MP3s file can usually be bettered when the bit rate is increased. This machine can play recordings between 8KBPS and 320 KBPS. However, in order to enjoy a good tone, we recommend discs over 128KBPS.

The tone of MP3s file can usually be bettered when the bit rate is increased. This machine can play recordings between 8KBPS and 320 KBPS. However, in order to enjoy a good tone, we recommend discs over 128KBPS.

The tone of MP3s file can usually be bettered when the bit rate is increased. This machine can play recordings between 8KBPS and 320 KBPS. However, in order to enjoy a good tone, we recommend discs over 128KBPS.

The tone of MP3s file can usually be bettered when the bit rate is increased. This machine can play recordings between 8KBPS and 320 KBPS. However, in order to enjoy a good tone, we recommend discs over 128KBPS.

The tone of MP3s file can usually be bettered when the bit rate is increased. This machine can play recordings between 8KBPS and 320 KBPS. However, in order to enjoy a good tone, we recommend discs over 128KBPS.

The tone of MP3s file can usually be bettered when the bit rate is increased. This machine can play recordings between 8KBPS and 320 KBPS. However, in order to enjoy a good tone, we recommend discs over 128KBPS.

The tone of MP3s file can usually be bettered when the bit rate is increased. This machine can play recordings between 8KBPS and 320 KBPS. However, in order to enjoy a good tone, we recommend discs over 128KBPS.

The tone of MP3s file can usually be bettered when the bit rate is increased. This machine can play recordings between 8KBPS and 320 KBPS. However, in order to enjoy a good tone, we recommend discs over 128KBPS.

The tone of MP3s file can usually be bettered when the bit rate is increased. This machine can play recordings between 8KBPS and 320 KBPS. However, in order to enjoy a good tone, we recommend discs over 128KBPS.

The tone of MP3s file can usually be bettered when the bit rate is increased. This machine can play recordings between 8KBPS and 320 KBPS. However, in order to enjoy a good tone, we recommend discs over 128KBPS.

The tone of MP3s file can usually be bettered when the bit rate is increased. This machine can play recordings between 8KBPS and 320 KBPS. However, in order to enjoy a good tone, we recommend discs over 128KBPS.

The tone of MP3s file can usually be bettered when the bit rate is increased. This machine can play recordings between 8KBPS and 320 KBPS. However, in order to enjoy a good tone, we recommend discs over 128KBPS.

The tone of MP3s file can usually be bettered when the bit rate is increased. This machine can play recordings between 8KBPS and 320 KBPS. However, in order to enjoy a good tone, we recommend discs over 128KBPS.

The tone of MP3s file can usually be bettered when the bit rate is increased. This machine can play recordings between 8KBPS and 320 KBPS. However, in order to enjoy a good tone, we recommend discs over 128KBPS.

The tone of MP3s file can usually be bettered when the bit rate is increased. This machine can play recordings between 8KBPS and 320 KBPS. However, in order to enjoy a good tone, we recommend discs over 128KBPS.

The tone of MP3s file can usually be bettered when the bit rate is increased. This machine can play recordings between 8KBPS and 320 KBPS. However, in order to enjoy a good tone, we recommend discs over 128KBPS.

The tone of MP3s file can usually be bettered when the bit rate is increased. This machine can play recordings between 8KBPS and 320 KBPS. However, in order to enjoy a good tone, we recommend discs over 128KBPS.

The tone of MP3s file can usually be bettered when the bit rate is increased. This machine can play recordings between 8KBPS and 320 KBPS. However, in order to enjoy a good tone, we recommend discs over 128KBPS.

The tone of MP3s file can usually be bettered when the bit rate is increased. This machine can play recordings between 8KBPS and 320 KBPS. However, in order to enjoy a good tone, we recommend discs over 128KBPS.

The tone of MP3s file can usually be bettered when the bit rate is increased. This machine can play recordings between 8KBPS and 320 KBPS. However, in order to enjoy a good tone, we recommend discs over 128KBPS.

The tone of MP3s file can usually be bettered when the bit rate is increased. This machine can play recordings between 8KBPS and 320 KBPS. However, in order to enjoy a good tone, we recommend discs over 128KBPS.

The tone of MP3s file can usually be bettered when the bit rate is increased. This machine can play recordings between 8KBPS and 320 KBPS. However, in order to enjoy a good tone, we recommend discs over 128KBPS.

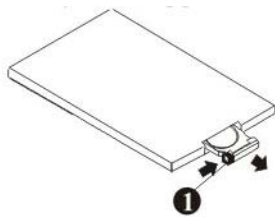

1. Pull out the Battery Holder while pressing the stopper.

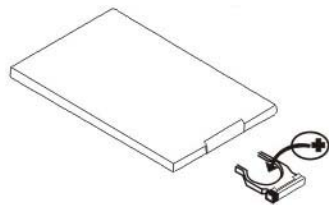

2. Put the button-type battery (+) mark upward into the battery holder.

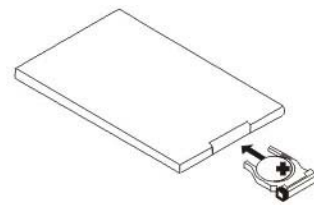

3. Insert the Battery Holder into the Remote Control.

## Remote Control

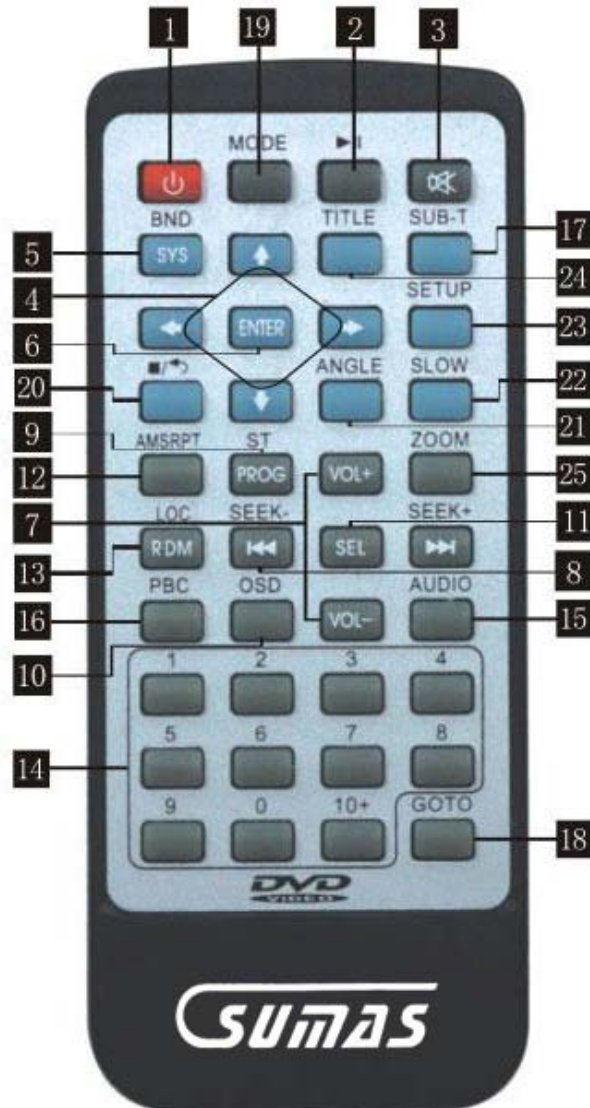

- |           |                                      |           |                      |
|-----------|--------------------------------------|-----------|----------------------|
| <b>1</b>  | Power Switch                         | <b>13</b> | Random Playing/LOC   |
| <b>2</b>  | Pause/Play Button                    | <b>14</b> | Number Button        |
| <b>3</b>  | Mute Button                          | <b>15</b> | Audio-Setting        |
| <b>4</b>  | Selecting Menu Button                | <b>16</b> | PBC Menu             |
| <b>5</b>  | System Switch                        | <b>17</b> | Subtitle-Setting     |
| <b>6</b>  | Enter Button                         | <b>18</b> | Playing Time-Setting |
| <b>7</b>  | Volume Control                       | <b>19</b> | Mode Switch          |
| <b>8</b>  | Tuning/Selecting<br>Tracks/F.F/REW   | <b>20</b> | Stop/Reverse Button  |
| <b>9</b>  | Program Playing                      | <b>21</b> | Angle-Setting        |
| <b>10</b> | On-Screen Display                    | <b>22</b> | Slow-motion Play     |
| <b>11</b> | Setting the Sound<br>Characteristics | <b>23</b> | Setup Menu           |
| <b>12</b> | Repeat Playing                       | <b>24</b> | Menu-Display         |
|           |                                      | <b>25</b> | Zoom-Setting         |

## REMOTE CONTROL FUNCTIONS

1. **Power Switch** – Press once to turn unit off press again to turn unit off
2. **Pause/Play Button** – Plays and pauses track while playing DVD, CD, USB, or SD
3. **Mute Button** – Enables and Disables Sound
4. **Selecting Menu Buttons** – Arrow keys to select and sort through features on the set Up menu.
5. **System/Band Switch** – To switch to different bands and between NTSC or PAL
6. **Enter Button** – To confirm change
7. **Volume Control** – To change audio levels
8. **Tuning/Selecting Tracks/F.F/REW** – To skip tracks and frequencies
9. **Program Playing** – To control programming on desired track play
10. **On-Screen Display** – To control the display of track/chapter or elapse time.
11. **Setting the Sound Characteristics** – To control Bass/Treble/Fader/Balance
12. **Repeat Playing** – To repeat tracks/charters
13. **Random Playing/LOC** - To play tracks randomly/to lock settings
14. **Number Buttons** – For switching the different store radio stations.
15. **Audio Setting** – To toggle between audio modes when playing DVD
16. **PBC** – Playback control for VCD
17. **Subtitle Setting** – To turn subtitle on/off
18. **GOTO** - Playing Time Setting
19. **Mode Switch** – To toggle between modes
20. **Stop/Go Back Button** – To stop playing tracks/to return to previous
21. **Angle Setting** – To change to different scene angles when playing DVD's
22. **Slow Motion** – To control movie playback speed
23. **Set Up Menu** – To change system settings
24. **Title/menu Display** – To show title of playing movie
25. **Zoom Setting** – To zoom in/out of videos

## Front Panel

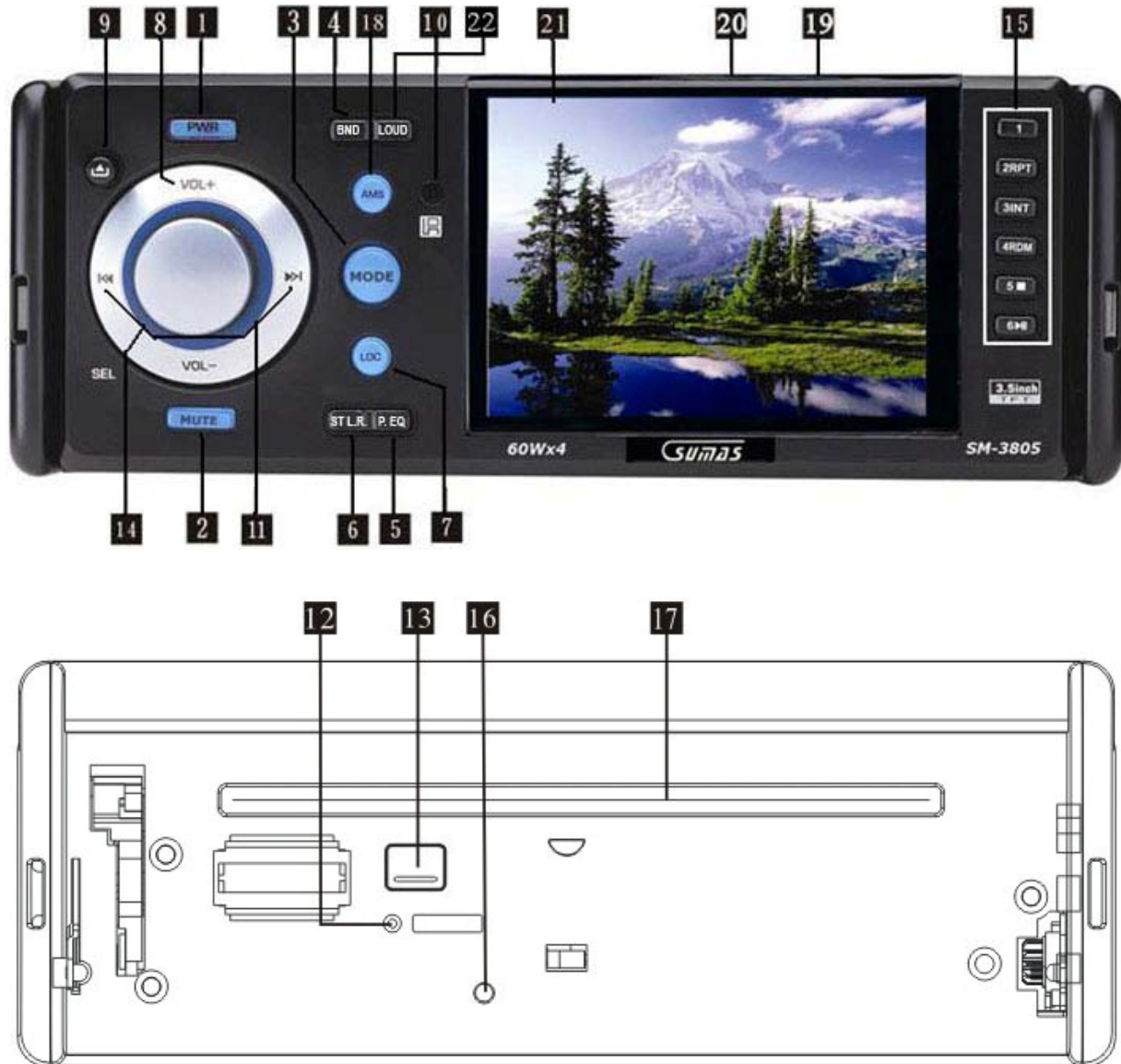

- |   |                                    |
|---|------------------------------------|
| 1. Power On/Off                             | 12. Reset Button                   |
| 2. Mute Button                              | 13. Eject Button                   |
| 3. Mode Switch                              | 14. SEL/CLK Button                 |
| 4. Band Selector                            | 15. Number Buttons                 |
| 5. P-EQ Button                              | 16. LED Lamp                       |
| 6. ST Selector                              | 17. Disc Slot                      |
| 7. Loc Button                               | 18. Preset Stations/AMS For radio  |
| 8. Volume Control                           | 19. USB Port (Refer to page 11)    |
| 9. Open/close button/Detaching panel button | 20. SD Socket (Refer to page 11)   |
| 10. Remote Control Receptor                 | 21. 3.5" Wide TFT Color LCD Screen |
| 11. Tuning/Selecting Tracks                 | 22. LOUD Button                    |



## FRONT PANEL FUNCTIONS

1. Power Button – To turn unit on/off
2. Mute Button – To turn volume on/off
3. Mode Switch – To toggle between different modes
4. Band Selector – To change between FM1/FM2/FM3/AM1/AM2
5. EQ Button – To toggle between preset equalizers
6. ST-Selector – To change audio from Stereo/Left/Right
7. LOC Button – To lock the buttons
8. Volume Control – To change volume level
9. Open/Close/Detaching button – For inserting disc or removing the faceplate
10. Remote Control Receptor – For receiving remote control signal
11. Tuning/Selecting Tracks – For selecting different tracks and tuning radio frequencies
12. Reset Button – To reset settings to factory default **(Use the push pin included)**
13. Eject Button – For ejecting inserted disc
14. SEL/CLK – Press to change sound settings, press and hold to view clock
15. Number Buttons – Use for store radio stations or disc controls
16. LED Lamp – Unit power indicator
17. Disc Slot – For inserting discs
18. Preset Stations/AMS for Radio – Automatic Memory Select for radio mode
19. USB Port – Use for USB flash drive or MP3 players
20. SD/MMC Card Slot – For memory card storage
21. 3.5" TFT Color LCD Screen – Display screen
22. LOUD button – Press to turn loudness on/off

# Basic Setup

## Powering the unit ON/OFF

- Press the **Power/Mode** button once to turn the unit on. Press and hold for a few seconds to turn the unit off.

**Note:** When using the remote just press **Power** button once to turn unit off.

## Switching Modes

- Press the **Power/Mode** Button on the unit repeatedly to cycle through the **Modes**. (DVD, Tuner, SD/MMC Card, USB)

**Note:** Unit will automatically switch to the proper mode once the following is inserted.  
(DVD/CD/VCD Disc, USB Flash Drive and SD/MMC memory card)

## System Setup

- This unit can display NTSC or PAL.
- To change the TV System setting press the "SETUP" key on the remote while on DVD/Musi/MP3/USB/SD mode, will show sub menu (as shown on Figure A) press **▼** to go to "TV System" then press **▶** right arrow to select the desired setting of the DVD movie then press enter button, or select "AUTO" to automatically change the setting depending on the DVD inserted.
- To quickly change TV system, simply press the "BND/SYS" to toggle between NTSC, PAL, or AUTO.

NOTE: Screen Saver can be turned on/off manually while in system setup. Simply scroll down, then select on/off

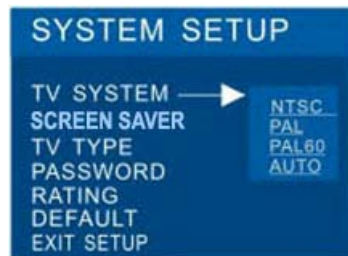

Fig A

## TV Type/Screen Size

- To setup screen size play back mode. Scroll down to "TV TYPE" while on "System Setup", then press **▶** right arrow to select the desired aspect ratio (**4:3PS**; **4:3LB**; **16:9**) then press "Enter".

## Movie Rating

- To change the rating on what DVD movies can be watched. While on System setup scroll down to "PASSWORD" then press **▶** right arrow then enter default password or "0000" (default) then scroll down to rating and select the desired rating and press "Enter". Then scroll back up to "PASSWORD" and enter password to lock.
- To change password, unlock "PASSWORD" using the default code (0000) once unlocked go back to code entry and press desired code. (must be 4 digits.)

Note: Make sure you write down your code and store in a safe place.

## Basic Setup cont.

### Language Setup

- To setup language press "SETUP" on remote while on any mode but radio. Then press ► once then scroll down to all options (OSD Language, Audio Lang, Subtitle Lang, Menu Lang and DIVX Lang) and change to the desired options.
- For example: to select OSD language scroll to "OSD LANGUAGE" then press ► and select desired language and press "Enter" Repeat for all other option.

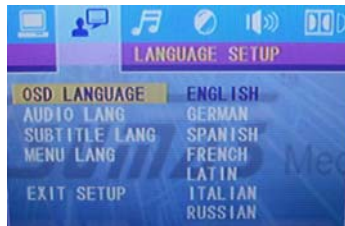

### Video Setting

- To change the **Brightness, Contrast, Hue, Saturation** and **Sharpness** press "SETUP" button on the remote then press ► 3x to get to video settings. Scroll down to and press enter to change the desired option. Use up and down arrow to change settings. Play with these options to get the desired setting.



### Audio Settings

- To change the **Volume, Bass, Treble, Balance,** and **Fader** options, simply press the "VOLUME" knob repeatedly to the desired option then rotate knob left/right to change or touch the screen on the desired option to change the settings. Play with these options to get the desired audio output.







### Clock Setup

- To set/change time: Go to **Radio Mode** press **SEL/CLK** button repeatedly until "Clock Mode" is reached, then press and hold button until hour changes color then push up/down to change time, press button again to select minutes and press up/down to change, When finish press and hold SEL/CLK button until color changes back to normal.





# Basic Operation

## Tuner/Radio Mode

- Press  **Power/Mode** button on the unit repeatedly until displays "**TUNER**" (Remote control use the "**MODE**" button.)
- **Band Select:** Press the "**BND**" to select **preset stations**
- **Manual Tuning:** Press  or  repeatedly to locate the desired frequency.
- **Automatic Tuning:** Press and hold  or  for available frequencies.
- **Storing Radio Stations:** To preset stations to the "**Number Buttons 1-6**" locate the station using  or  then press and hold the desired number button (1-6) a beep will sound when set. Repeat for other number buttons and Band section (FM1, FM2, etc...)
- **Automatic Radio Station Storing:** To randomly store available frequencies to the number buttons, simply press the "**AMS**" button.





\*NOTE: This unit can store up to 18 FM frequencies (FM1=6, FM2=6, FM3=6) and up to 12 AM frequencies (AM1=6 AM2=6).

## Music/MP3 CD Mode

- **Inserting a CD:** Press the  "**Release**" button to open front panel then insert a Music or MP3 Disc into the disc slot. (make sure label is facing up) then push front panel back into place. Unit should automatically switch to "**DISC**" mode. The unit will start playing the first track on the CD.
- **Track Select:** To skip forward or backwards through the tracks simply press  or .
- **Random Playing:** Press "**RDM**" button once to play track in random order press again to turn random off.
- **Repeat Play:** Press "**RPT**" button to repeat what's currently playing, press again to turn off repeat play. For MP3 playing to repeat a whole folder press "**RPT**" 2x and 3x to turn off random.
- **INTRO Playing:** Press the "INT" button to play the first 10seconds of each track on the CD press again to stop.

\*NOTE: Intro Play is not available for MP3/DVD mode.



## DVD Mode

- **Inserting a DVD:** Press the  "**Release**" button to open front panel to insert DVD or VCD Disc into the disc slot. (Make sure label is facing up) then flip the panel back into place. Unit should automatically switch to "**DVD**" mode. If not press "**SRC**" repeatedly until DVD mode is reached. The unit will start playing the content of the DVD.
- To skip or find chapters simply press  or  to find the desired track or chapter.
- Press  to pause and play movie.
- To zoom picture, press "**ZOOM**" button repeatedly on remote to zoom (**2x, 3x, 4x, 1/2, 1/3, 1/4**).
- For "**Subtitle**". Simply press "**SUB-T**" on the remote to turn on/off.
- For **Slow Motion** mode, press "**SLOW**" on the remote 1x=1/2 2x=1/3...6x=1/7 8x to turn off.
- For "**Repeat playing**" press "**2RPT**" once to repeat "Chapter" (current track), twice for "Title" (the entire movie), and three times to end repeat play.

# Basic Operation cont.

## USB/SD Mode

Note: USB PORT is for flash drive only, will not work for IPOD.

- **Inserting a USB** media device: Using the provided mini USB to USB converter plug in device into the unit. (unit will automatically switch to **USB/SD** mode. If audio files are present, then the first track will play automatically. To view pictures press the ► right arrow on the ▲ remote then ◀ left until the  is highlighted on the bottom of the screen, then ► press “Enter” then press ▲ up arrow and then “Enter”. For playing Videos repeat above step but highlight  on the bottom of the screen.

\*Note: Random play is only available on pictures and audio files. Repeat play is available on all.

## AUX MODE

- To use **Auxiliary** mode: Plug in the RCA cable for your device into the back RCA “ **Aux Input** ” of the unit, Press **Mode** button repeatedly to select **Aux** mode.

\*Note: You can only control your device functions through your device.

With this unit; if/when you install a Sumas brand rear camera, you can connect the video feed through Camera input. When car in reverse will display the rear view.

## Trouble Shooting

Problem	Reason	Conclusion
The unit will not turn on	Incorrect wiring connections.	Make sure all the wires are properly connected. Please refer to the wiring diagram
Cannot use the remote control	Insufficient battery power. Or obstacle blocking remote sensor.	Replace battery. (page 2) and make sure there is nothing blocking the path of the remote control to the sensor.
DVD/CD will not play, Or will not play properly.	Disk is dirty or scratched. Disc isn't suitable for this unit. The video system of the disc is incompatible with the unit	Clean the disc with a soft cloth. Check disc compatibility. (see page 2) / Change to another discs that is compatible with your system.
No sound/Volume or will not increase	Incorrect connection with the cables The unit is on mute / playing frame by frame /or fast forwarding or rewinding is turned on.	Make sure all the speaker cables are connected properly with the unit and to the speakers themselves. Un-Mute the unit.
Certain speaker will not output sound	Incorrect setup of the sound fields. Speaker might be damage.	Make sure all the connections from the unit and from the speakers are properly connected. Make sure all the speakers work properly.
LCD does not display picture, or say "picture off for safety." on screen.	"PARK SW" wire is not connected properly to the hand brake wiring. Car is moving. Parking brake is not applied. ("Picture off for safety"); wiring not properly connected.	Pictures will only appear when parking brake is applied for safety. Check wiring and make sure everything is properly connected. Consult a professional installer, Make sure "PARK SW" wire is properly connected to the park brake or ground. ( see page 1 )
When the power switch is turned on, there is a loud motor noise.	The machine is reading the disc. The Disc Drive is resetting to its normal position.	Normal function.
USB flash drive will not read.	Loose or dirty connection. Stored file are not supported or files are corrupt.	Check/clean connection. Make sure the flash drive USB was firmly inserted into USB adaptor and the adaptor is securely inserted to the USB port. Make sure no corrupt files
No caption/subtitle.	You can only switch between items that are being displayed. Your current DVD disc does not have Caption.	Press "SUB-T" on the remote to switch on, If it will not display caption by Using disc menu to switch. To make sure this DVD movie has caption/subtitle.
Does not play in the language or caption desired	Current disc may not have different or limited language or caption.	Make sure DVD movie has caption/subtitle with the desired language.
The pictures are obscure, distorted or blurred	Some discs have Anti- copy information on them, and will not read discs that have been copied	This machine is compatible with anti-copy system, However there may be some parallel lines or disturbances while playing. This does Not mean this machine is defective.
Does not play MP3 file	It will only play files with .mp3 as Mp3 do not use this extending name with a non Mp3 files	Correctly name the files you are playing as .mp3/4. Make sure the files are correct MP3 audio files. (.WAV, or .WMA files that are renamed with .MP3/4 will not work) Audio files must be converted into .MP3 files.
Does not play MP4 file	MP4 video requires supported codec.	See page 3 (MP4).

# Specifications

## General

- Power Requirements ..... 12 V DC
- Load Impedance ..... 4Ω
- Tone Control ..... ±8dB (Bass 100Hz, Treble 10KHz)
- Dimensions ..... Approx. 7.50"x6.75"x2" (D x W x H)
- Mounting Dimensions ..... 8"x7.25"x2.50" (D x W x H)
- Weight ..... 4.4lbs

## DVD Deck Section

- Disc Play ..... MP4, DVD, VCD 1.0/1.1/2.0/3.0, MP3, CD, CD-R, CD-RW, PICTURE-CD
- Video System ..... Auto/NTSC/AUTO
- Mounting Angle ..... 0° to +/- 30°

## Video Section

- Video System ..... 4:3 Letter Box 4:3 Pan Scan
- Video Output Level ..... 1.0Vp-p 75 ohms
- Horizontal Resolution ..... 500 lines

## Audio Section

- Maximum Output Level ..... 2Vrms (+/-3dB)
- Frequency Response ..... 20 to 20KHz
- Signal-to-Noise Ratio ..... 85dB
- Separation ..... 80dB

## AM Tuner Section

- Frequency Range ..... 530-1710 (USA)
- IF Range ..... 450 KHz
- Usable Sensitivity (-20dB) ..... 25dB

## FM Tuner Section

- Tuning Range ..... 87.5 – 107.9
- IF Range ..... 10.7 MHz
- Usable Sensitivity (-30dB) ..... 15dB
- Signal-to-Noise Ratio ..... 60dB
- Stereo Separation ..... 30dB (1KHz)
- Frequency Response ..... 30~15000Hz

# Accessories

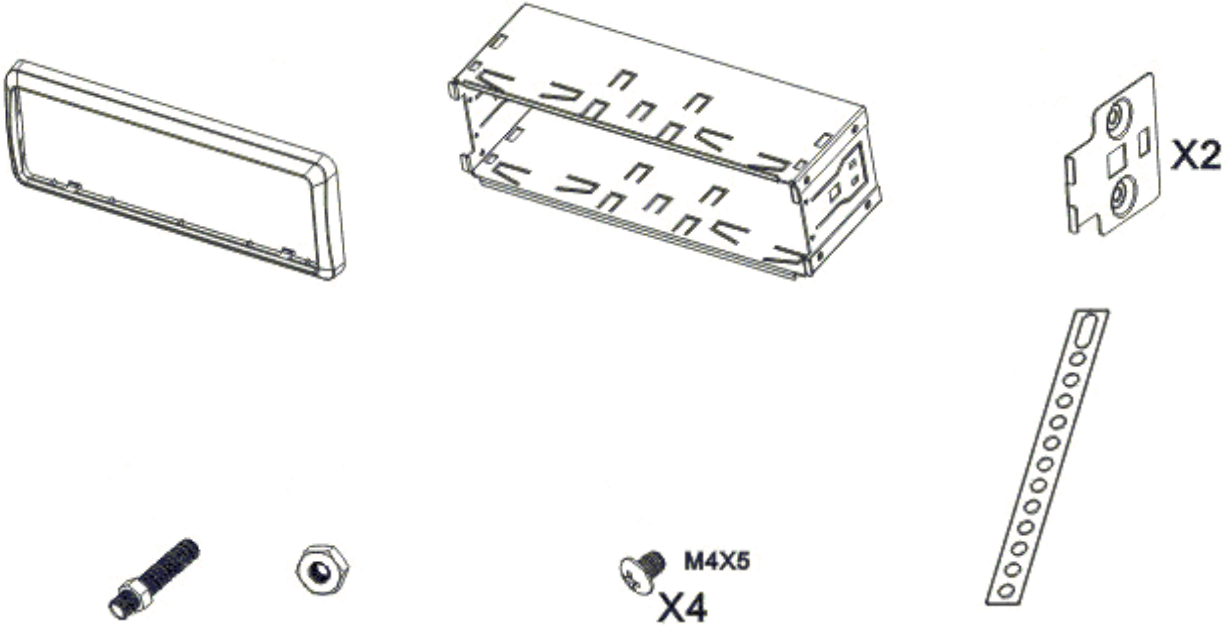

All above items as installation kit (please see page 2)



Extractors

Push pin

Wiring Harness

Wiring Diagram



Faceplate Caddy



Remote Control



Operation Manual



USB Converter